



WATER PRODUCT CATALOGUE

Fresh water deserves a safe connection



TABLE OF CONTENTS



INTRODUCTION	4
The company	4
Product development	6
COMPOSITE PRODUCTS	8
Flexi	10
Eco Line	18
Sprint	24
Seal Liner	32
GT Fittings	34
Tapping Sadle	36
Accessories	42
BRASS PRODUCTS	44
Mechanical couplings	48
Building block system	54
Brass gate valve system	58
Support Insert	60
Threaded Pipe Fittings	62
Accessories	70
DUCTILE IRON PRODUCTS	74
ENVIRONMENTAL POLICY	78
GENERAL CONDITIONS OF SALE	80

INTRODUCTION



THE COMPANY

Isiflo AS is producing high quality products for the Water, Wastewater and Gas utility sector. All development and production are made locally in Norway and Sweden. Isiflo AS has subsidiaries in Germany, France, Sweden, Denmark and The Netherlands and is represented in more than 30 countries worldwide through the sales network of agents and distributors.

Our products are made in both Composite PA12 material as well as in DZR (Dezincification Resistant) Brass and most of them fit all kind of pipes. Isiflo is a leading brand in the European utility industry. Isiflo has a long tradition for innovation with the active support from NCE Raufoss (Norwegian Centres of Expertise).

COMPANY PROFILE

The first Isiflo couplings were introduced to the market back in 1965. In 2004 we joined the Dutch industrial group Aalberts NV. Our headquarter is based in Raufoss Industrial Park in Norway and we are member of the industrial cluster NCE Manufacturing Raufoss. This is a cluster of companies in defence, aerospace, automotive, utility and consumer markets, working together in a technology hub with SINTEF Manufacturing AS as facilitator for exchange of technology and best practice between the companies within the cluster. This is a program supported by the Norwegian state for a learning environment where companies from different sectors come together and share best practice between each other, in consecutively improvement, also in alliance with the academia.

OUR WORLDWIDE NETWORK

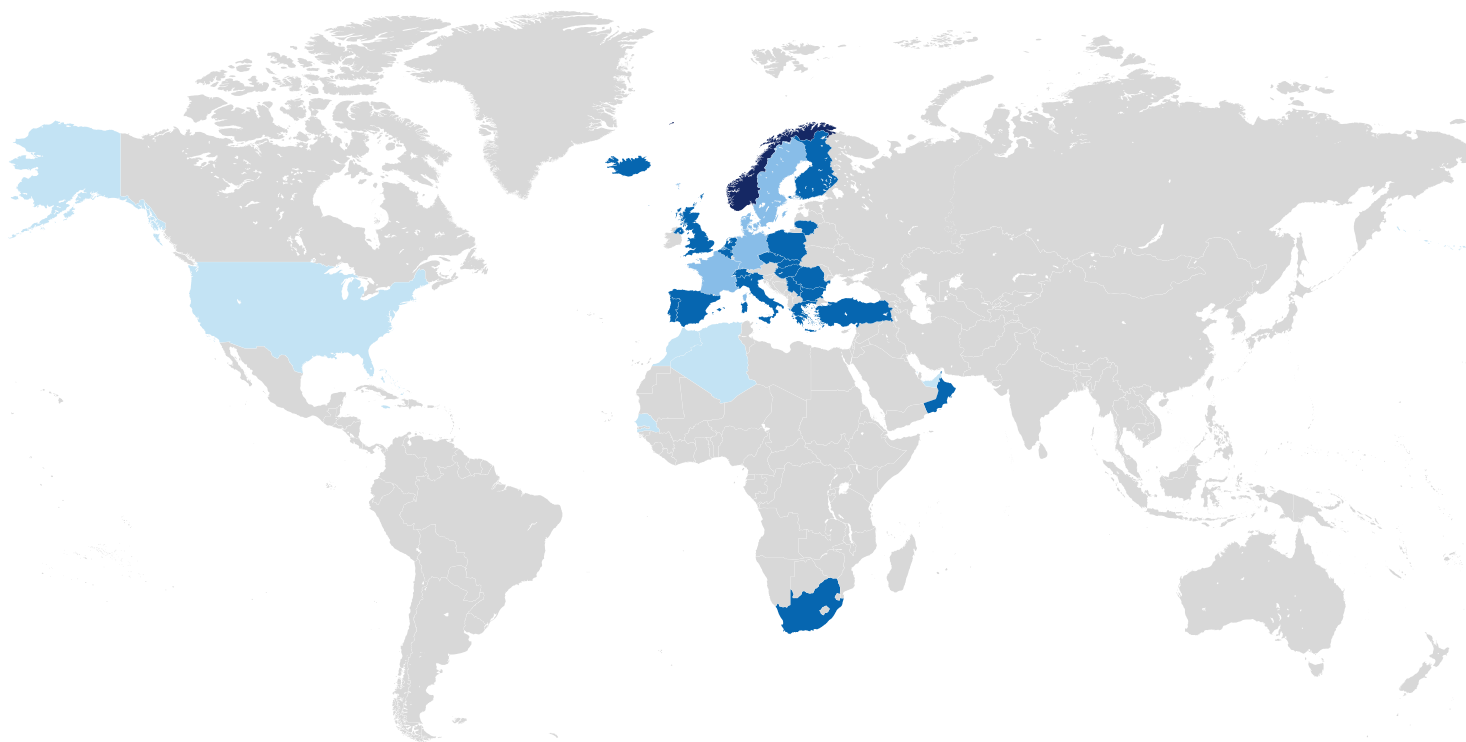

1 HEADQUARTER

Our Headquarter is situated in Raufoss Industrial Park:
- Norway

2 SUBSIDIARIES

Our subsidiaries are located in:
- Denmark
- France
- Germany
- Sweden
- The Netherlands

3 DISTRIBUTORS

We have distribution in:
- Austria
- Bulgaria
- Belgium
- Czech Republic
- Finland
- Great Britain
- Greece
- Hungary
- Iceland
- Italy
- Latvia
- Lithuania
- Luxembourg
- Poland
- Portugal
- Romania
- Slovakia
- Spain
- Switzerland
- Turkey
- Oman
- South Africa

4 AGENTS

We have representative agents in:
- Algeria
- Bahamas
- Bahrain
- Jamaica
- Morocco
- Senegal
- United Arab Emirates
- USA

PRODUCT DEVELOPMENT

Clean water is vital for all living organisms on earth. The loss of fluids during a day must be replenished preferably by potable water (drinking quality). Water may contain detrimental micro organisms and other elements which make it unsuitable for human consumption and use. The choice of right material therefore has the highest priority when producing our products. Our products for water are approved through the strictest testing and carry the certificates from DVGW, KIWA Gastec, ÖVGW etc. The tests are carried out according to EN437/ EN1555/ISO17885. Isiflo Sprint is certified by KIWA Gastec for hydrogen use. Isiflo Brass couplings has been gas approved since 1971 and holds certificate from DWGV, KIWA Gastec and ÖVGW.

INNOVATION

Our Sprint couplings are a result of a cooperation between the development team of Isiflo and the members of NCE Manufacturing in Raufoss Industrial Park. The target was to develop the best coupling in a material combining mechanical properties comparable with metals and corrosion resistance comparable to plastics. By using only the best materials to secure extreme lifetime, we ended on a high tech composite which is a Glass Fiber Reinforced Polymer (GFRP). The goal of the design was to develop the best coupling in composite that makes the life for the user easier and save installation time with a solution that does not require special tools or education. This secures the best quality of the piping system and secures a reliable supply of water through the distribution network.

Our Brass Couplings are traditional compression couplings which have been under constant development and improvements since 1965, both regarding material use and design. It is a well recognised mechanical coupling made in corrosion resistant material.



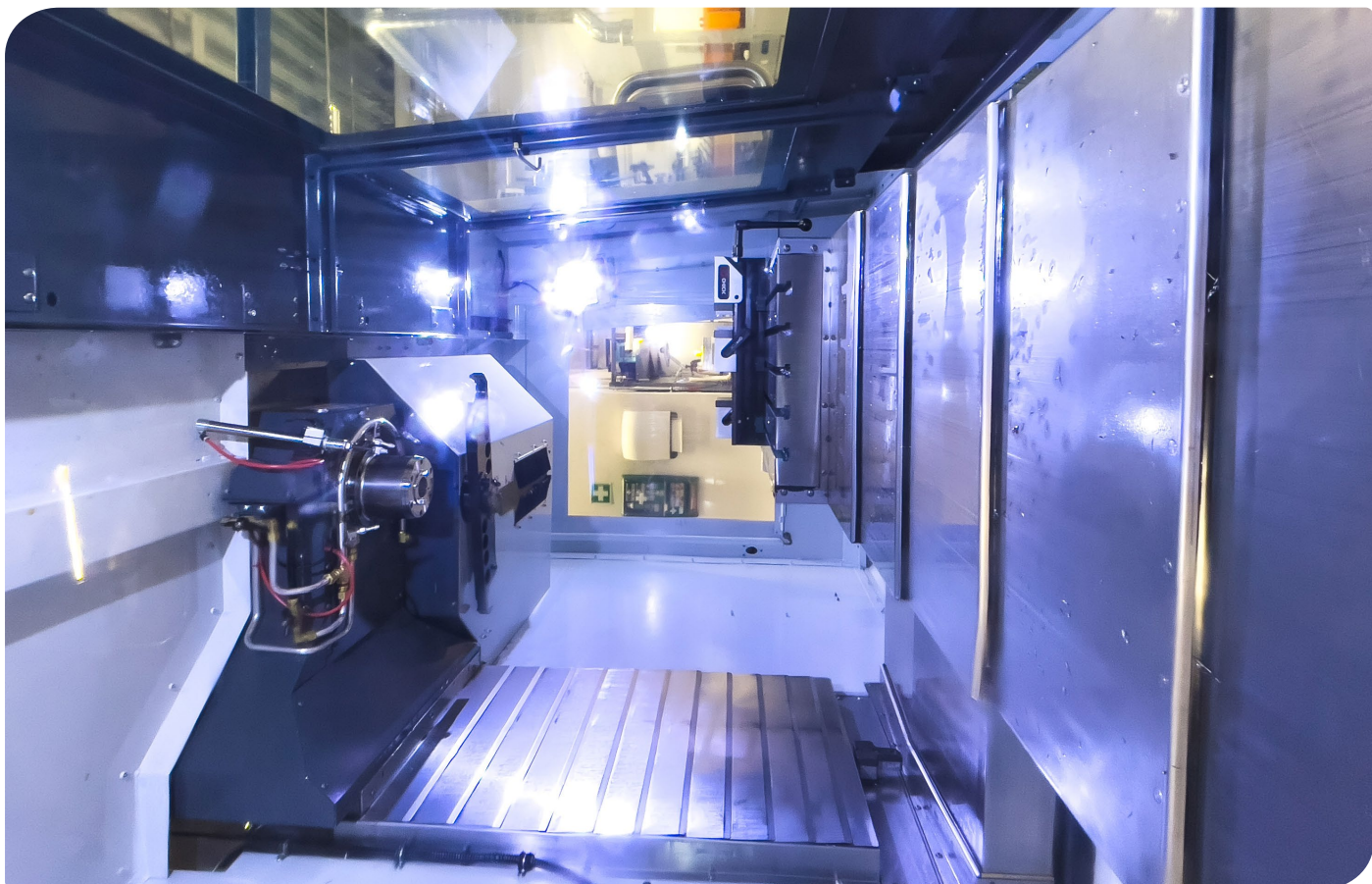

PRODUCTION AND QUALITY SYSTEMS

All our products are produced in Norway according to the strictest QA and HSE regulations. The production is certified according to ISO 9001:2015 and ISO 14001:2015.

FUNCTION

In our product range you can choose from push-in, mechanical couplings and threaded fittings.

SUSTAINABILITY AND SHARED VALUE CREATION

Our production plant in Raufoss is using only renewable energy in the production. The assembly of the products is done in a labour training centre. This was established in 2014 by Isiflo, together with the local labour office to assist people to improve their job qualification. This includes language training for foreigners and education in QA / HSE systems – which is mandatory for a job qualification. This has shown to be the best integration program in Norway. Isiflo takes social responsibility and care for people.

COMPOSITE PRODUCTS



THE MATERIAL

Our composite products are made from glassfibre reinforced polyamide (PA12), developed for high strength and long life. The material technology together with the design makes the Isiflo products industry leading in strength and performance. Our composite couplings are lead free and corrosion resistant, which results in environmental friendly products with a very long lifetime.

FUNCTION

The designs are based on a time saving push-in solution. The patented sealing system has a push-back ring that activate the grip-ring and compress the sealing in one simple move. This secure a tight connection, even at vacuum and low pressure systems.

SUSTAINABILITY

Our products are produced and assembled in our new factory in Raufoss, Norway. They are produced with renewable energy and has no emissions to the environment.

COMPOSITE MATERIAL CHARACTERISTICS

The Composite material can be molded into different shapes. By controlling the flow orientation of the fibres, the Isiflo products can be designed in a unique way. These characteristics give the material flexible use in many different industries.

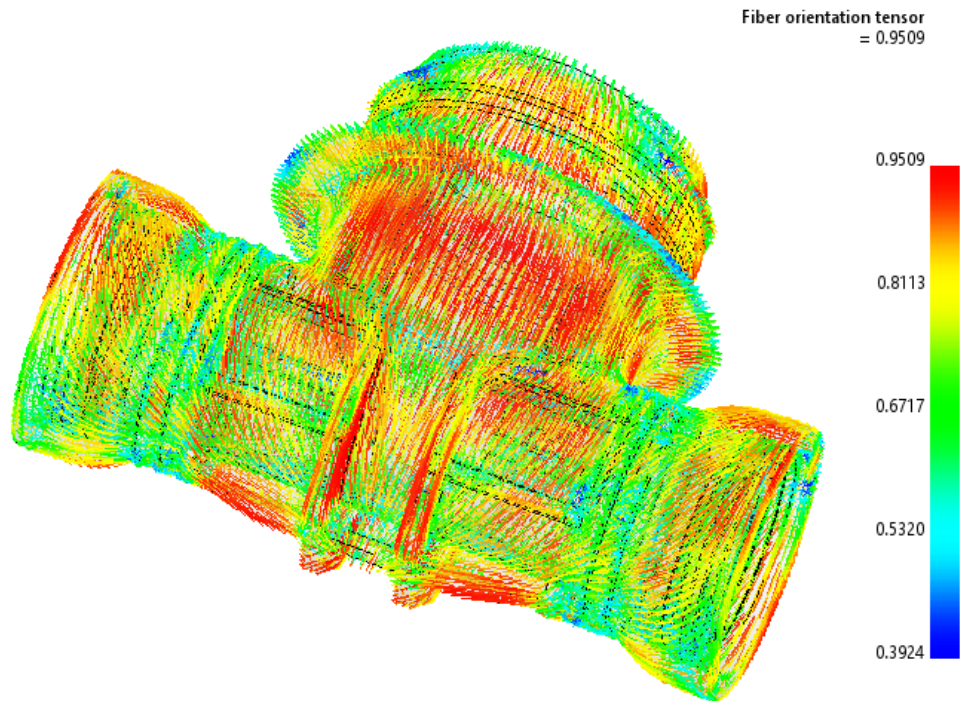

ADVANTAGES

The Composite material offers many advantages; in addition to being a sustainable choice, it's a user friendly material with many important properties as:

- CORROSION FREE
- LIGHT WEIGHT
- EXTREME MECHANICAL STRENGTH
- LONG LIFE TIME

FUN FACT

The Airline Industry is constantly increasing the use of Composite material. For instance, the 787 Dreamliner is constructed by more than 50% composite by weight!

FLEXI



ONE FITTING FOR ALL KIND OF PIPES

Flexi is a family of couplings and adaptors customized for water supply, providing a simple connection with low installation torque and without the need of any special tools for assembly.

The special designed rocket (with POM clamp ring and metal nails) ensures an end-load resistant connection when the nut is fully tightened. The Flexi products can be used on all type of pipes.

This product range includes Flexi Coupling, Flexi Adaptor and Flexi - Flexi.

TECHNICAL INFORMATION

MATERIAL DESCRIPTION

BODY

Glass fibre reinforced Polyamide (PA12)

O-RING

EPDM

COMPRESSION CARTRIDGE

POM (Polyoxymethylene)

NAILS

AISI 316 (up to 35mm), Aluminium Bronze (from 35 to 63mm)

AREA OF USE

WATER

Temperature: 0°C to 40°C

Operating pressure: Max 16 bar

Pipes: PE, PEX, PVC, PPR, Copper, Steel, Lead and other types

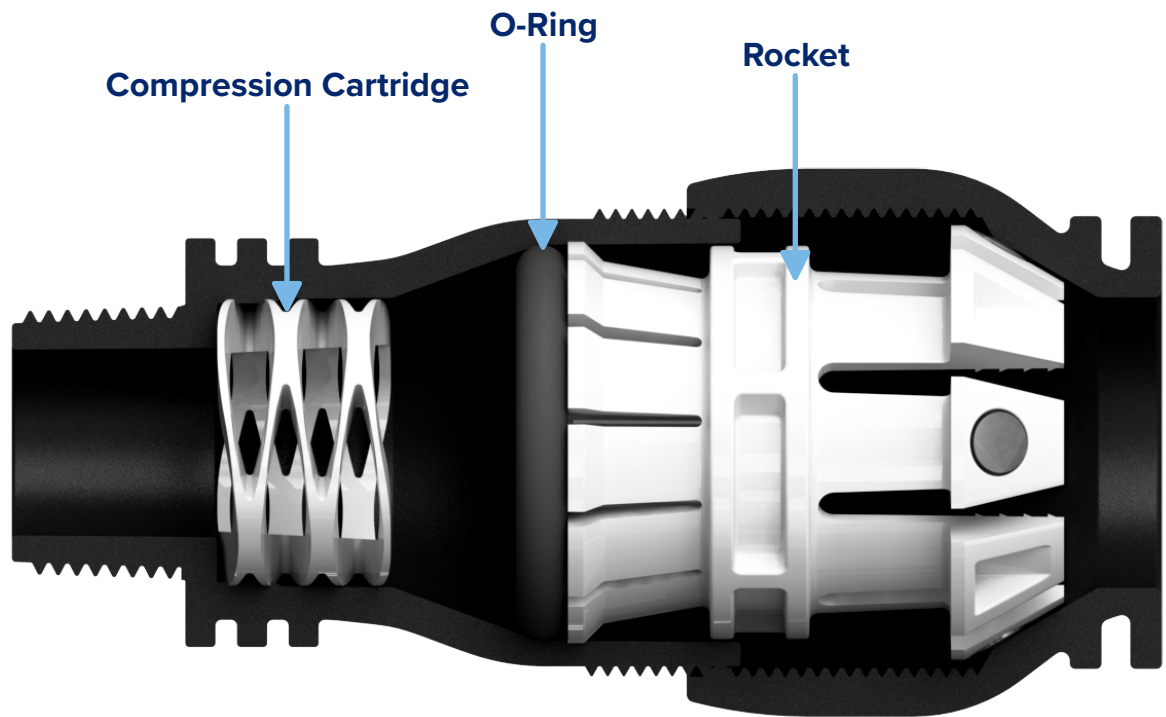

INSTALLATION INSTRUCTIONS

FLEXI X FLEXI

1.

Cut the pipe straight and mark the insert depth on the pipe. If one pipe end is loose, install the coupling on the tight end first.

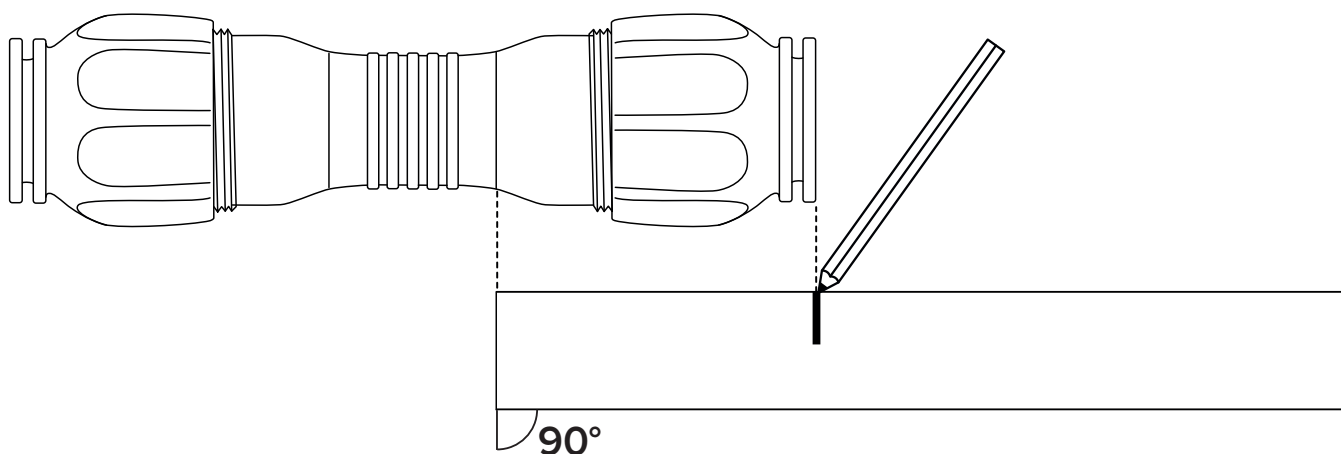

2.

Insert the pipe into pipe stop and tighten the nut by hand (equivalent to about 12Nm), before one turn with pipe wrench.

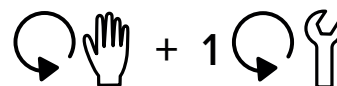
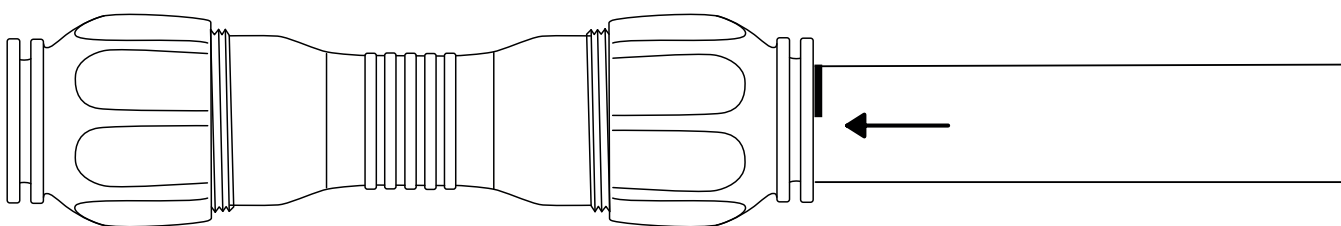

FLEXI COUPLING AND ADAPTER

1.

Cut the pipe straight

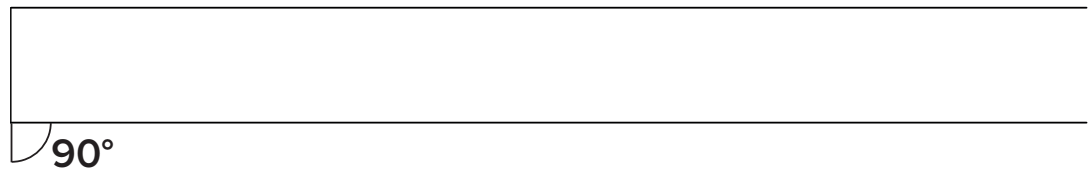

2.

Insert the pipe to the end of coupling and tighten the nut by hand (equivalent to about 12Nm) before one turn with pipe wrench for dimensions 15-22, 20-27 and 27-35 mm, and two turns for dimension 35-50 and 49-63 mm

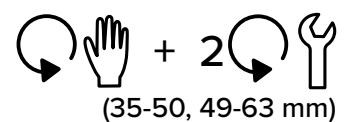
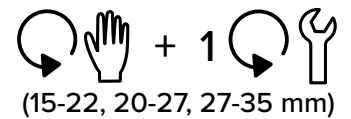
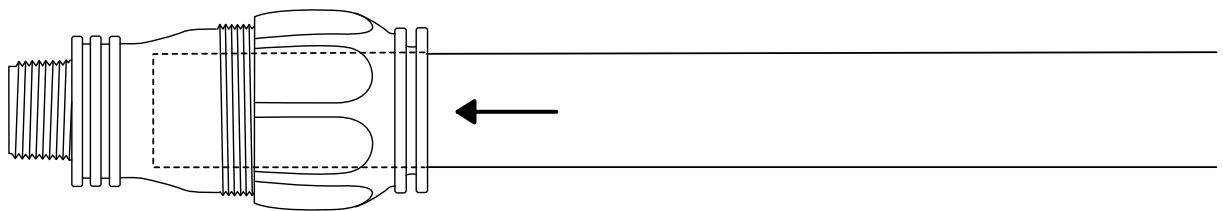

PS: When used on old plastic pipes, use caution when tightening. Questions? Contact support

FLEXI PRODUCTS

TYPE 101: FLEXI - FLEXI

D x D	Item Number
20-27 x 20-27	8221012
27-35 x 27-35	8221013



TYPE 104: FLEXI SPRINT

For all types of pipes in both plastic and metal. With the exception of multilayer pipes such as Alupex pipes.

D x Di	Item Number
15-22 x 20mm	8221041
20-27 x 25mm	8221042
20-27 x 32mm	8221043
20-27 x 40mm	8221044
27-35 x 25mm	8221045
27-35 x 32mm	8221046
27-35 x 40mm	8221047
35-50 x 32mm	8221048
35-50 x 40mm	8221049
35-50 x 50mm	8221051
49-63 x 32mm	8221052
49-63 x 40mm	8221054
49-63 x 50mm	8221050
49-63 x 63mm	8221053



TYPE 136 FLEXI ADAPTER

Connects with all our brass mechanical couplings

D x Di	Item Number
15-22 x 20mm	6221000
15-22 x 25mm	6220009
20-27 x 25mm	6221001
27-35 x 25mm	6221002
27-35 x 32mm	6221003
35-50 x 40mm	6221004
49-63 x 50mm	6221005



TYPE 113 FLEXI MALE COUPLING

D x R	Item Number
20-27 x ¾"	8220004
20-27 x 1"	8220005
27-35 x ¾"	8220024
27-35 x 1"	8220007
35-50 x 1 ¼"	8220028
35-50 x 1 ½"	8220008
49-63 x 2"	8220009

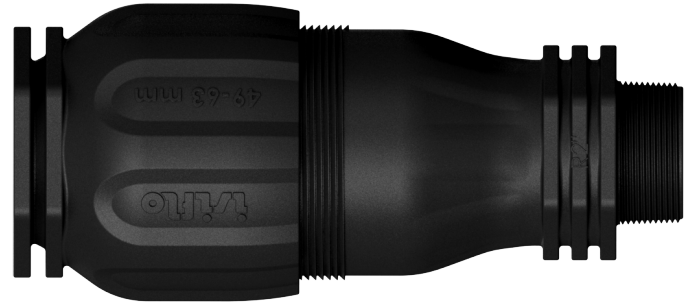

TYPE 114 FLEXI FEMALE COUPLING

D x G	Item Number
20-27 x ¾"	8220014
20-27 x 1"	8220015
27-35 x ¾"	8220124
27-35 x 1"	8220017
35-50 x 1 ¼"	8220028
35-50 x 1 ½"	8220018
49-63 x 2"	8220019



FLEXI SET FOR REUSE

D	Item Number
15-22mm	6220001
20-27mm	6220002
27-35mm	6220003
35-50mm	6220004
49-63mm	6220005

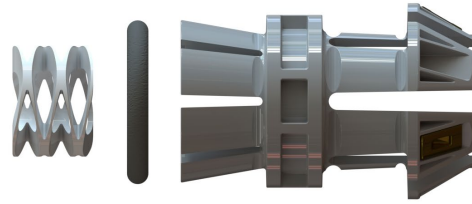

ISIFLO BRICK BUILDING SYSTEM

The Flexi-adapters can be connected with all our brass mechanical couplings which gives the Isiflo building system unique flexibility.

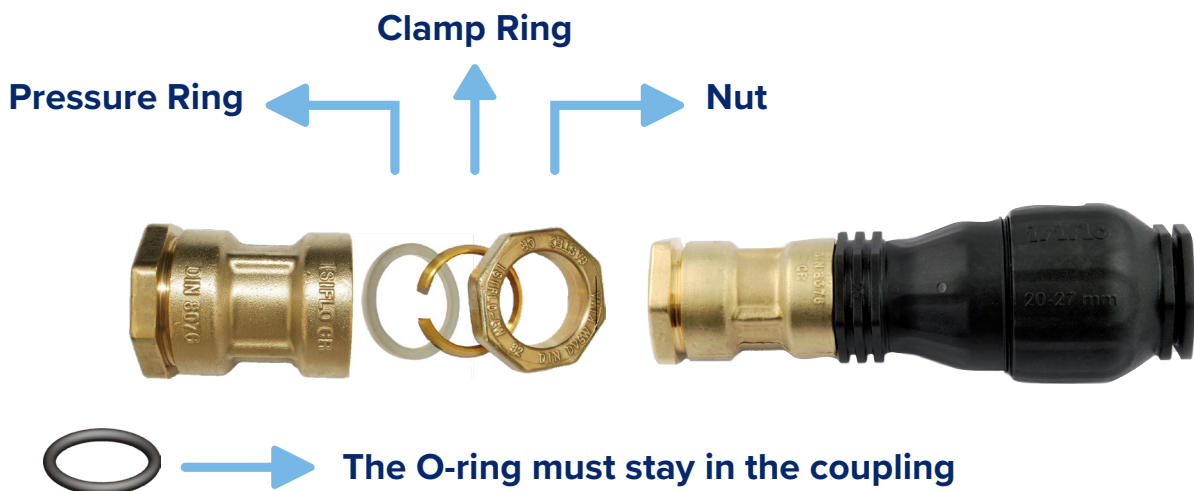

Remove nut, clamp ring and pressure ring.

NB: O-ring must always remain inside the coupling!

New part is tightened to impact.

D = Dimension (OD) in mm

Di = Isiflo's thread dimension

R = Conical pipe thread acc. to ISO 7

G = Cylindrical pipe thread acc. to ISO 228

NOTES:



isiflo®

ECO LINE

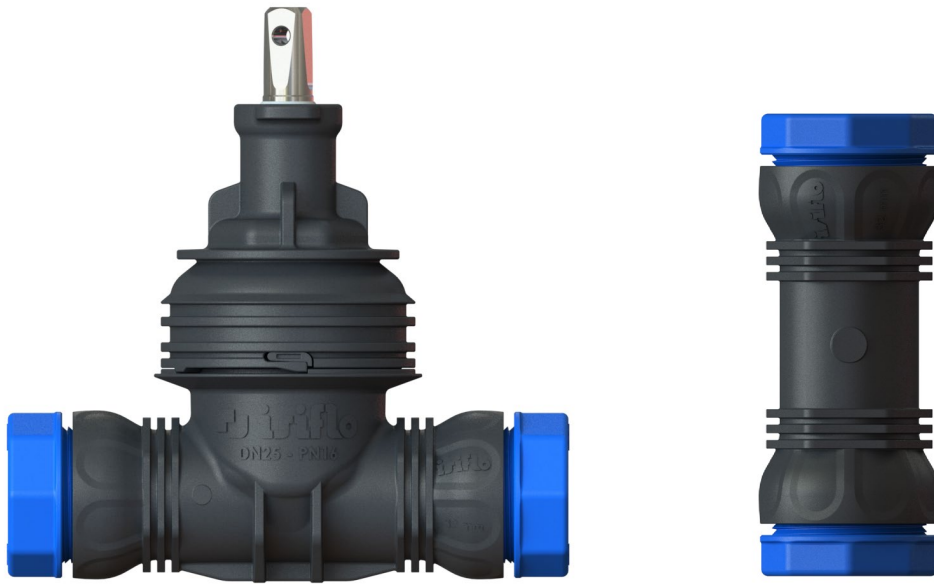

A SUSTAINABLE CHOICE THAT FITS ALL PLASTIC PIPES

Since 2003 Isiflo has experimented with different composite materials. Eco Line is the newest addition to our range of Composite products. Our composite products are constructed on the same quality standards as our brass products and have 20 years warranty. All components in the couplings and adaptors can be recycled by the end of life. The products are easy to use, are corrosion free and can be used under ground.



TYPE 101: ECO LINE REPAIR COUPLING

DxD	Item Number
25 x 25	8211013
32 x 32	8211014
40 x 40	8211015
50 x 50	8211016
63 x 63	8211017



Our new Eco Line Repair Coupling for water is a crossover from two worlds. It has many of the same advantages as our recognized brass repair coupling, but is manufactured in the same high tech composite materials as our Sprint couplings.

The choice of material results in a corrosion resistant connection, without any material sagging over time.

INSERT DEPTH ECO LINE REPAIR COUPLING

D	Insert Depth		Max distance between pipe ends
	(min.)	(max.)	
25 mm	42 mm	58 mm	42 mm
32 mm	46 mm	63 mm	44 mm
40 mm	59 mm	79 mm	56 mm
50 mm	63 mm	86 mm	62 mm
63 mm	82 mm	103 mm	62 mm

TYPE 135: PE REDUCER

Di x D	Item Number
32 x 25	8211354
63 x 50	8211357



TYPE 136: PE PUSH-IN ADAPTOR

Di x D	Item Number
32 mm x Sprint 32 mm	8211364



TYPE 144: DOUBLE CONNECTION NIPPLE

Di x Di	Item Number
32 x 32 mm	8211444
40 x 40 mm	8211445
63 x 63 mm	8211447



D = Dimension (OD) in mm

Di = Isiflo's thread dimension

R = Conical pipe thread acc. to ISO 7

G = Cylindrical pipe thread acc. to ISO 228

TYPE 146 / 147: MALE ADAPTOR

Di x R	Type	Item Number
32 x 1 1/4"	146	8212464
32 x 1"	147	8212474
40 x 1 1/4"	147	8212475
63 x 2"	147	8212477
63 x 1 1/2"	147	8212479



TYPE 148: FEMALE ADAPTOR

Di x R	Item Number
32 x 1"	8212484
40 x 1 1/4"	8212485
63 x 2"	8212487



TYPE 200: ECO LINE GATE VALVE

D x D	DN	Item Number
25 x 25	20	8212003
32 x 32	25	8212004
40 x 40	32	8212005
50 x 50	40	8212006
63 x 63	50	8212007



TYPE 201: ECO LINE ARCTIC FROST-PROOF GATE VALVE

D x D	DN	Item Number
32 x 32	25	8212014
40 x 40	32	8212015

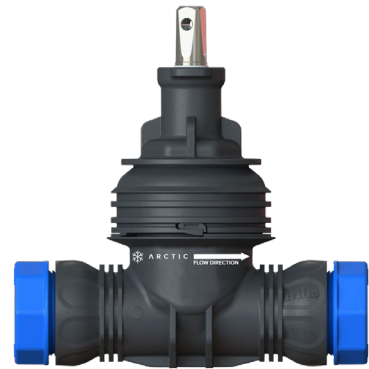

ECO LINE TAPPING VALVE

D x R	DN	Item Number
32 x 1 1/4"	32	8212995

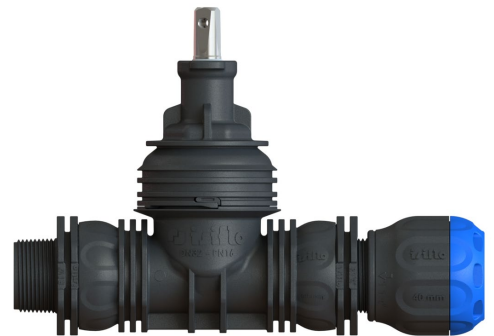

TYPE 293: ECO LINE GATE VALVE WITH MALE X FEMALE THREADS

R x R	Item Number
1" x 1"	8212934
1 1/4" x 1 1/4"	8212935



TYPE 291: ECO LINE GATE VALVE WITH FEMALE THREADS X PE CONNECTION

D x R	Item Number
32 x 1"	8212914
40 x 1 1/4"	8212915



D = Dimension (OD) in mm
 Di = Isiflo's thread dimension
 R = Conical pipe thread acc. to ISO 7
 G = Cylindrical pipe thread acc. to ISO 228

TYPE 292: ECO LINE GATE VALVE WITH MALE THREADS X PE CONNECTION

Dimension DxD (mm)	Item Number
32 x 1"	8212924
40 x 1 1/4"	8212925



TYPE 290: ECO LINE GATE VALVE WITH PE CONNECTION

Dimension DxD (mm)	Item Number
32 x 32	8212904
40 x 40	8212905



TYPE 294: ECO LINE GATE VALVE WITH FEMALE X FEMALE THREADS

Dimension DxD (mm)	Item Number
1" x 1"	8212944
1 1/4" x 1 1/4"	8212945



TYPE 295: ECO LINE GATE VALVE WITH PUSH-IN ENDS

Dimension DxD (mm)	Item Number
32 x 32	8212954
40 x 40	8212955

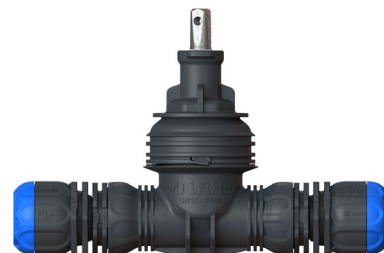

TYPE 229: DOUBLE SWIVEL ELBOW

Dimension DxD (mm)	Item Number
32 x 32	8212294
40 x 40	8212295



ECO LINE GATE VALVE FLANGE

Dimension DxD (mm)	Item Number
32 mm	8212604



ECO LINE GATE VALVE MANIFOLD FOR UTILITY CHAMBER

Dimension DxD (mm)	Item Number
50 x 32 mm / 4 gate valves	8212514
50 x 32 mm / 6 gate valves	8212534
50 x 32 mm / 8 gate valves	8212554
50 x 32 mm / 10 gate valves	8212574
50 x 32 mm / 12 gate valves	8212594



SPRINT



PUSH-IN COUPLINGS FOR PE, PEX AND PVC PIPES

Sprint is a group of push-in couplings that combines strength, safety, durability and user friendliness. The interaction between the push-back ring, O-ring and the clamp ring gives a safe, leak free and tensile connection without the use of special tools.



TECHNICAL INFORMATION

MATERIAL DESCRIPTION

BODY

Glass fibre reinforced Polyamide (PA 12)

O-RING

EPDM

PUSHBACK RING

POM (Polyoxymethylene)

CLAMP RING

POM (Polyoxymethylene)

AREA OF USE

WATER

Temperature: 0°C to 40°C

Operating pressure: Max 16 bar

Pipes: PE after NS-EN 12201 or NS-EN 1555, PVC after NS-EN 1452 with use of PVC-kit, PEX with use of seal liner.

IMPORTANT!

Always use our Seal Liner especially developed for use with Sprint to have an approved and safe connection!

Not recommended to be used on moulded PE-pipes!

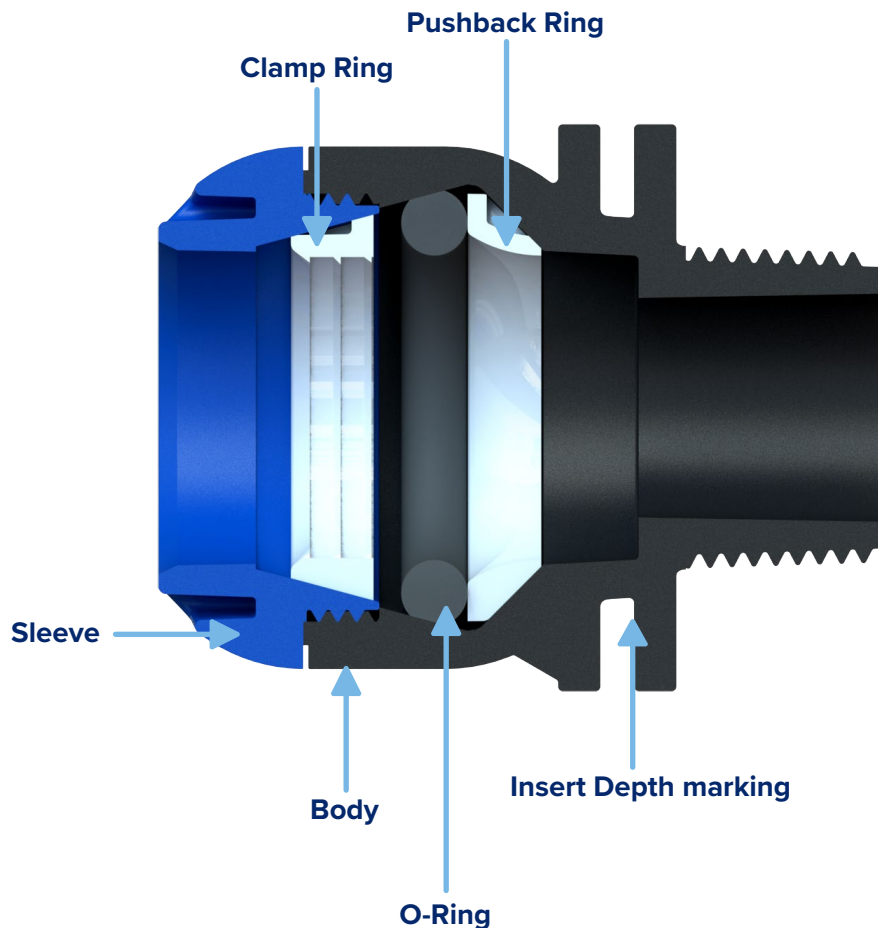

INSTALLATION INSTRUCTIONS

1.

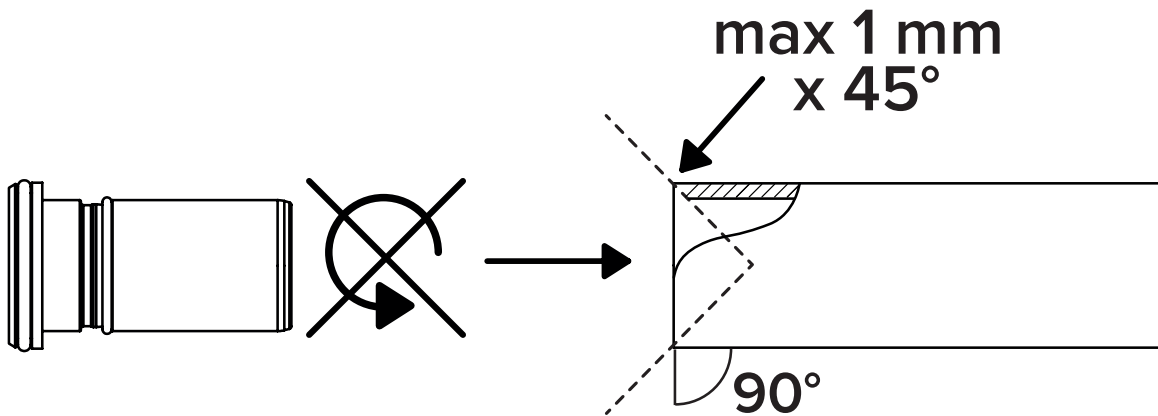

2.

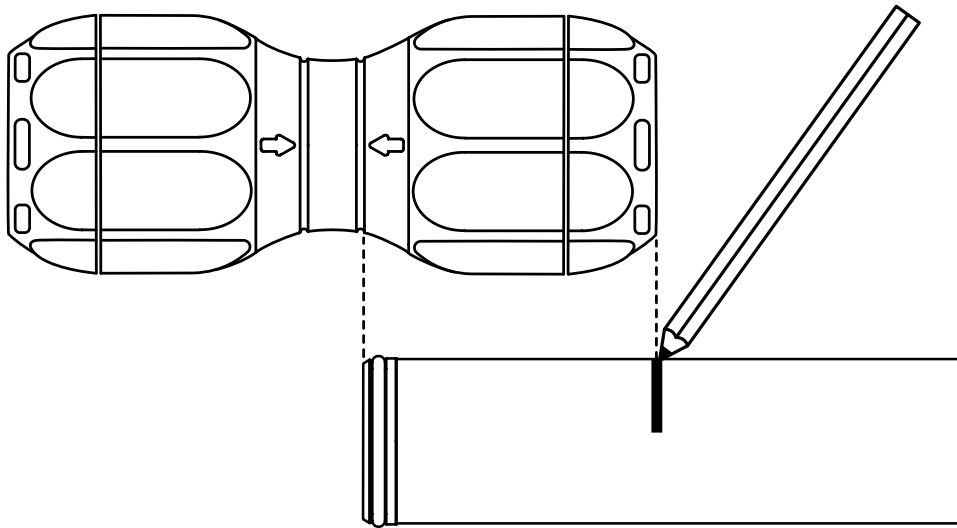

3.

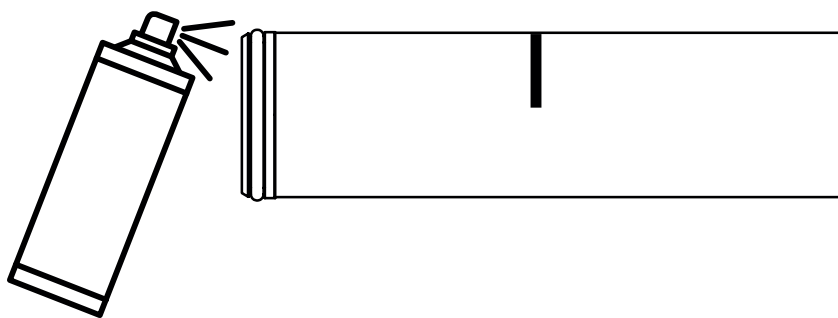

4.

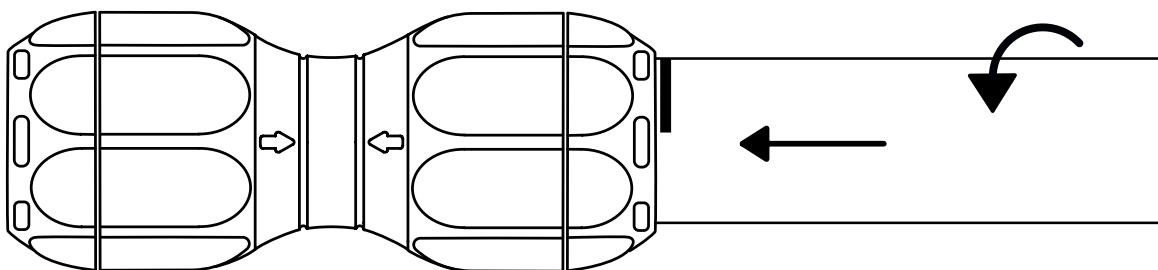

SPRINT PRODUCTS

TYPE 100: STRAIGHT COUPLING

D x D	Item Number		
	PE	PVC	PE - PVC
20 x 20	8211002	-	-
25 x 25	8211003	8251003	8254003
32 x 32	8211004	8251004	8254004
40 x 40	8211005	8251005	8254005
50 x 50	8211006	8251006	8254006
63 x 63	8211007	8251007	8254007



TYPE 102: STRAIGHT REDUCER

D x D	Item Number		
	PE	PVC	PE - PVC
25 x 20	8211021	-	-
32 x 20	8211026	-	-
32 x 25	8211022	8251022	8254022
40 x 32	8211023	8251023	-
50 x 32	8211028	8251028	-
50 x 40	8211024	8251024	-
63 x 32	8211020	-	-
63 x 50	8211025	8251025	-



TYPE 105/110/112: MALE COUPLING

D x R	Item Number	
	PE	PVC
20 x 1/2"	8211102	-
25 x 3/4"	8211103	8251103
25 x 1"	8211053	8251053
32 x 3/4"	8211124	8251124
32 x 1"	8211104	8251104
32 x 1 1/4"	8211054	8251054
32 x 1 1/2"	8211058	8251058
32 x 2"	8211059	8251059
40 x 1"	8211125	8251125
40 x 1 1/4"	8211105	8251105
40 x 1 1/2"	8211055	8251055
50 x 1 1/2"	8211106	8251106
50 x 1 1/4"	8211126	8251126
50 x 2"	8211056	8251056
63 x 2"	8211107	8251107



D = Dimension (OD) in mm

R = Conical pipe thread acc. to ISO 7

G = Cylindrical pipe thread acc. to ISO 228

TYPE 115/116: FEMALE COUPLING

D x R	Item Number	
	PE	PVC
20 x 1/2"	8211162	-
25 x 3/4"	8211163	8251163
25 x 1"	8211153	8251153
32 x 3/4"	8211169	8251169
32 x 1"	8211164	8251164
32 x 1 1/4" (GT)	8211154	8251154
40 x 1"	8211161	8251161
40 x 1 1/4"	8211165	8251165
50 x 1" (GT)	8211160	8251160
50 x 1 1/2"	8211166	8251166
63 x 2"	8211167	8251167



TYPE 315/316: FEMALE COUPLING FOR FLAT SEALING

D x G	Item Number	
	PE	PVC
25 x 3/4"	8213163	
25 x 1"	8213153	
32 x 1"	8213164	
32 x 1 1/4"	8213154	



TYPE 120: ELBOW 90°

D x D	Item Number		
	PE	PVC	PE - PVC
20 x 20	8211202	8251202	-
25 x 25	8211203	8251203	8254203
32 x 32	8211204	8251204	8254204
40 x 40	8211205	8251205	8254205
50 x 50	8211206	8251206	8254206
63 x 63	8211207	8251207	8254207



TYPE 121/124: MALE ELBOW 90°

D x R	Item Number	
	PE	PVC
20 x 1/2"	8211212	-
25 x 3/4"	8211213	8251213
32 x 1"	8211214	8251214
32 x 2"	8211219	8251219
40 x 1"	8211245	8251245
40 x 1 1/4"	8211215	8251215
40 x 1 1/2"	8211218	8251218
50 x 1 1/4"	8211246	8251246
50 x 1 1/2"	8211216	8251216
63 x 2"	8211217	8251217



TYPE 123: ELBOW 45°

D x D	Item Number	
	PE	PVC
32 x 32	8211234	8251234
40 x 40	8211235	8251235
50 x 50	8211236	8251236
63 x 63	8211237	8251237



TYPE 122: FEMALE ELBOW 90°

D x R	Item Number	
	PE	PVC
25 x 3/4" (*)	8211223	8251223
25 x 3/4" (**)	8211229	8251229
25 x 1" (**)	8211220	8251220
32 x 1" (*)	8211224	8251224
32 x 1" (**)	8211221	8251221
40 x 1 1/4" (*)	8211225	8251225
50 x 1 1/2" (*)	8211226	8251226
50 x 1 1/2" (**)	8211228	8251228
63 x 2" (**)	8211227	8251227



* Female Elbow with adapter T148



** Female Elbow with GT Fitting

** Female Elbow with adapter T148

* Female Elbow with GT Fitting

TYPE 125: TEE

D x D x D	Item Number	
	PE-PE-PE	PVC-PVC-PVC
20 x 20 x 20	8211252	-
25 x 25 x 25	8211253	8251253
32 x 32 x 32	8211254	8251254
40 x 40 x 40	8211255	8251255
50 x 50 x 50	8211256	8251256
63 x 63 x 63	8211257	8251257



TYPE 132: FEMALE TEE

Dimension D x R x D	Item Number	
	PE	PVC
25 x ¾" x 25	8211323	8251323
32 x 1" x 32	8211324	8251324
40 x 1 ¼" x 40	8211325	8251325
50 x 1 ½" x 50	8211326	8251326



TYPE 165: END CAP

D	Item Number	
	PE	PVC
20	8211652	-
25	8211653	8251653
32	8211654	8251654
40	8211655	8251655
50	8211656	8251656
63	8211657	8251657



TYPE 148/149: FEMALE ADAPTOR

D x R	Item Number
25 x ¾"	8211483
32 x 1"	8211484
40 x 1 ¼"	8211485
50 x 1 ½"	8211486



NOTES:



isiflo®

SEAL LINER



WHY USE SEAL LINER

The inner surface of the pipe is mostly perfect and undamaged, therefore we seal it with our patented Isiflo Seal Liner. This gives a secure inner and outer seal to the PE pipe.

Benefits

- Timesaving and easy installation
- No need for special tools
- No special qualifications needed

THE TRIPPLE SEALING FUNCTION

The ISIFLO Seal Liner secure tightness through a triple sealing:

1st seal:

Between the liner and the inner surface of the pipe.

3rd seal:

Between the coupling and the outer surface of the pipe.

2nd seal:

Between the pipe end and the body of the coupling.

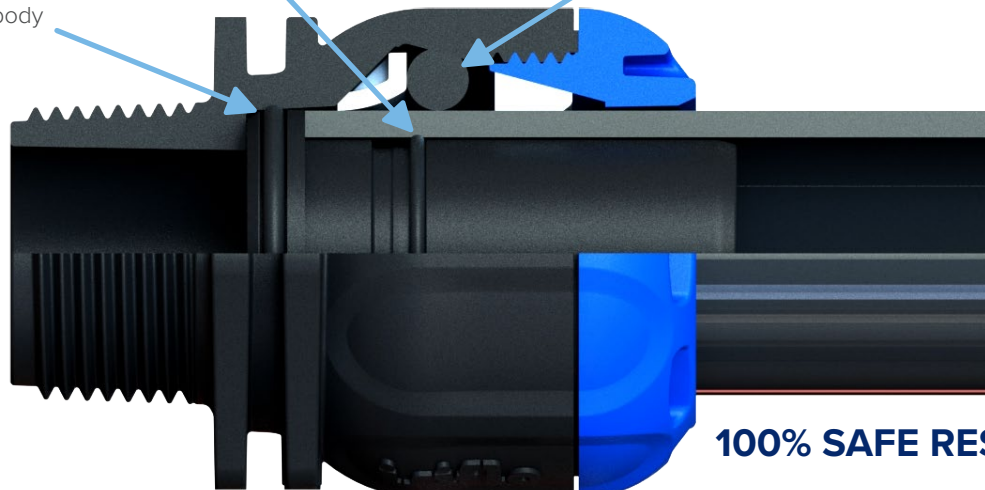

100% SAFE RESULT!

Venturi principle in Composite Material

The Isiflo Seal Liner is produced in composite material and designed with a “Venturi principle” to optimize flow and prevent pressure drop and flow restrictions.

Areas of Application

- Drinking Water Distribution
- Gas Systems
- Underpressure (Vacuum) systems
- Compressed air



For Assembly Instructions see page 20.

TYPE 182: SEAL LINER

Dimension D	Item Number
20 x 3,0 SDR 11	8211828
25 x 3,0 SDR 11	8211829
32 x 3,0 SDR 11	8231824
40 X 3,7 SDR 11	8231825
50 x 4,6 SDR 11	8231826
63 x 5,8 SDR 11	8231827
25 x 2,3 SDR 17	8231823

GT-FITTINGS



Our GT-fittings in composite material are threaded fittings for connecting with the use of hemp, tape or equal. Liquid paste can also be applied. The GT-fittings are cylindrical threaded fittings, male and female from 3/4" - 2". Because the parts are made from composite material they are not electrically conductive, and can be used as an isolator between two different types of metal to avoid galvanic corrosion. If electrical conduction is desirable, our brass threaded fittings may be used instead.

TECHNICAL INFORMATION

MATERIAL DESCRIPTION

FITTING

Glass fibre reinforced Polyamide (PA 12)

AREAS OF USE

WATER

Temperature: 0°C to 40°C

Operating pressure: Max 16 bar

THREAD

Conical (G) and/or cylindrical (R) threads, and threaded pipes for flat seal

OUR GT-FITTINGS

Dimension	Item Number
Socket G 3/4"	8011516
Socket G 1"	8011519
Socket G 1-1/4"	8011523
Socket G 1-1/2"	8011526
Socket G 2"	8011533
Socket G 1" x G 3/4"	8011729
Socket G 1 1/2" x G 1"	8011739
Socket G 2" x G 1 1/2"	8011749
Flat seal G1-1/4" M x Flat seal G1" F	8016893
Flat seal G1"mal x Rp1" fem	8018001
Flat seal G1"mal x Rp1-1/2" fem	8018002
Flat seal G1"mal x Rp1-1/4" fem	8018003
Flat seal G2"mal x Flat seal G1" fem	8018004
Flat seal G1-1/2"mal x Rp1-1/2" fem	8018005

D = Dimension (OD) in mm

R = Conical pipe thread acc. to ISO 7

G = Cylindrical pipe thread acc. to ISO 228



TAPPING SADDLE



Our tapping saddles has a unique patented concept for mechanical tapping of plastic pipes. The positioning/ securing of the saddle is easy done by a lever arm system, and a spring loaded compensator is providing a constant sealing against the pipe.

Advantages:

- Constant O-ring compression
- The compensator maintains a secure sealing during the tapping saddles lifetime
- Quick and easy to install
- Can be delivered with different valves and pipe thread solutions

TAPPING SADDLE SYSTEM



TYPE 190: TAPPING SADDLE

Dimension	Item Number
63 mm	6241900
90 mm	6241902
110 mm	6241903
125 mm	6241904
160 mm	6241906



TYPE 197: FITTING

Type and dimension	Item Number
Pipe thread 1 ¼"	6241971
Pipe thread 2"	6241973



TYPE 198: VALVE

Type and dimension	Item Number
Brass ball valve 2"	6241985
Straight ball valve w/adapter 1 ¼" (2"-1 ¼", for 160mm tapping saddle)	6241986
Straight valve DN32	6241981



TYPE 198: TAPPING VALVE

Type and dimension	Item Number
Brass tapping valve DN32	6241982
POM tapping valve DN20	6241983



INSTALLATION INSTRUCTIONS

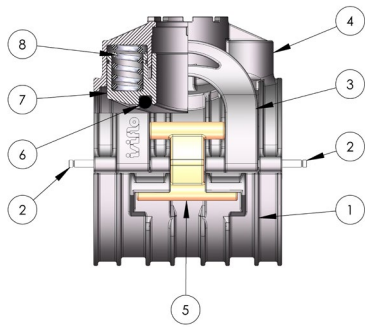

1. Lower housing
2. Locking pin
3. Buckle
4. Upper housing
5. Lower buckle
6. Sealing O-ring
7. Compensator
8. Spring

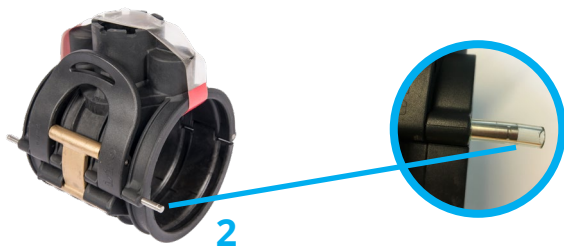

Remove safety tape and cover from the locking pins (2).

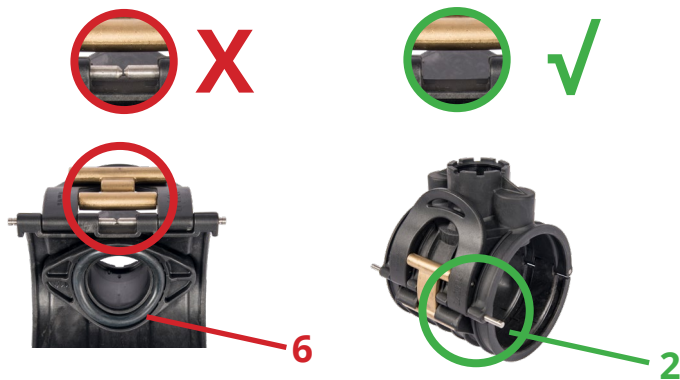

Check the position of the locking pins (2). Make sure that they are in the outer position. Ensure that the sealing O-ring (6) are correctly located. Make sure that your pipe is within the right dimension and tolerances. *(see overview last page)



Place the saddle onto the pipe, apply the lower half shell horizontally. Make sure that the installation area on the pipe is scratch-free. If the temperature is below 5°C, the pipe must be preheated before installing the ISIFLO Tapping Saddle.

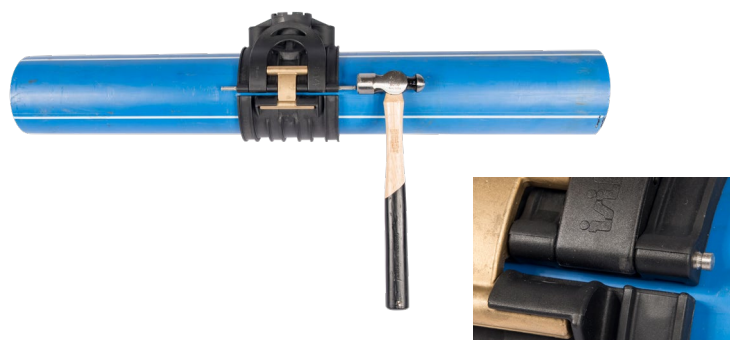

Secure the Lower buckle (5) by gently tapping the Locking pins (6) into place. The pins are correctly located when about 5mm of each pin is left protruding.



Choose the designated application: valve or threaded outlet (A). Remove the protective cap (C). Ensure the two lubricated o-rings (B) are correctly located on either side of the valve or threaded outlet. Make sure the lock-ring (D) is in position and correctly mounted.

(The chamfer has to be placed in direction of assembly.)

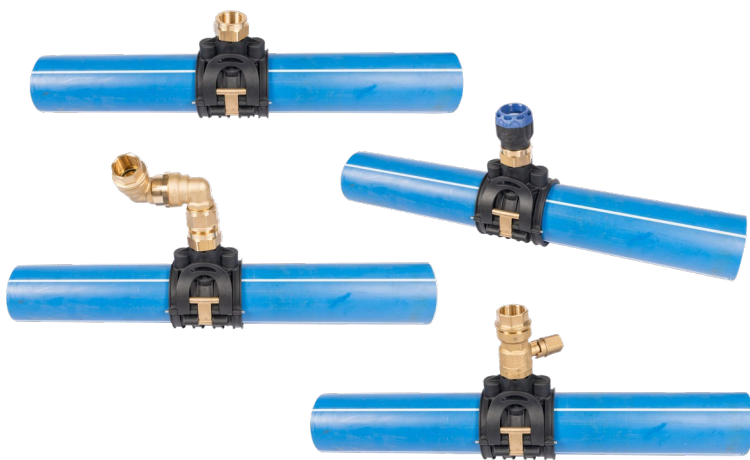

Insert the application and push firmly down through the mounting hole into of the ISIFLO Tapping Saddle. To finish the assembly, push the lock-ring into an interlocking position. The fastening will be confirmed by a clicking sound. Try to pull the application out to check if it is correctly mounted. The ISIFLO Tapping Saddle is now ready to begin with the tapping.



After use, the saddle can be easily dismantled by using a hammer and a wire-cutter. Remove the locking pins (6) until the serrated area becomes visible.



*Pipe	Mean outside diameter (EN12201-7 & EN1555-2) mean measurement of 4 values)
Ø63mm	dem,max Ø63,4
Ø90mm	dem,max Ø90,6
Ø110mm	dem,max Ø110,7
Ø125mm	dem,max Ø125,8
Ø160mm	dem,max Ø161,0

TAPPING TOOL SET

Type & dimension	Item Number
Tapping tool set	6242921
Content in box	Item Number
Drill bits:	
20mm	6242932
25mm	6242927
31mm	6242928
42mm	6242937
49mm	6242929
Spindler:	
XL-spindle 341mm	6242938
L-spindle 266mm	6242931
S-spindle 206mm	6242934
XS-spindle 156mm	6242936
Other:	
Ratchet	6242930
Holder 1 ¼"	6242923
Holder 2"	6242924
Feeding sleeve	6242925
Fitting 148-40 x 1 ¼"	6211485
Fitting 1" x 1 ¼"	5011889



ACCESSORIES

SPRINT DISASSEMBLY/ASSEMBLY TOOL

Dimension	Item Number
20-63mm	8211940



TYPE 180: SUPPORT INSERT SDR 11

Dimension DxD (mm)	Item Number
20x2,0 mm	8211802
25x2,3 mm	8211803
32x3,0 mm	8211804
40x3,7 mm	8211805
50x4,6 mm	8211806
63x5,8 mm	8211807



TYPE 181: SUPPORT INSERT SDR 17

Dimension DxD (mm)	Item Number
32x2/2,3 mm	8211814
40x2,4mm	8211815
50x3,0 mm	8211816
63x3,8 mm	8211817

TYPE 182: SEAL LINER

Dimension D	Item Number
20 x 3,0 SDR 11	8211828
25 x 3,0 SDR 11	8211829
32 x 3,0 SDR 11	8231824
40 X 3,7 SDR 11	8231825
50 x 4,6 SDR 11	8231826
63 x 5,8 SDR 11	8231827
25 x 2,3 SDR 17	8231823



NOTES:



isiflo®

BRASS PRODUCTS

THE MATERIAL

Our brass products are made in RA455 (CW625N) which is a special dezincification resistant brass (DZR). Our brass alloy undergoes a hot forging where the brass becomes a mixture of alpha and beta grains. Beta grains contain a slightly higher concentration of zinc which makes the alloy easy to forge. To achieve the right quality, the forging temperature must be controlled and repeatable in line with the cooling process. This process secures a corrosion free material with long lifetime.

PRODUCTION

Our most traditional product group are the brass couplings which have been manufactured in our plant since 1965. It has been subject of continuous development, production improvement and testing. Our brass couplings are tensile, corrosion resistant and has increased wall thickness which ensures strength and durability.





TECHNICAL INFORMATION

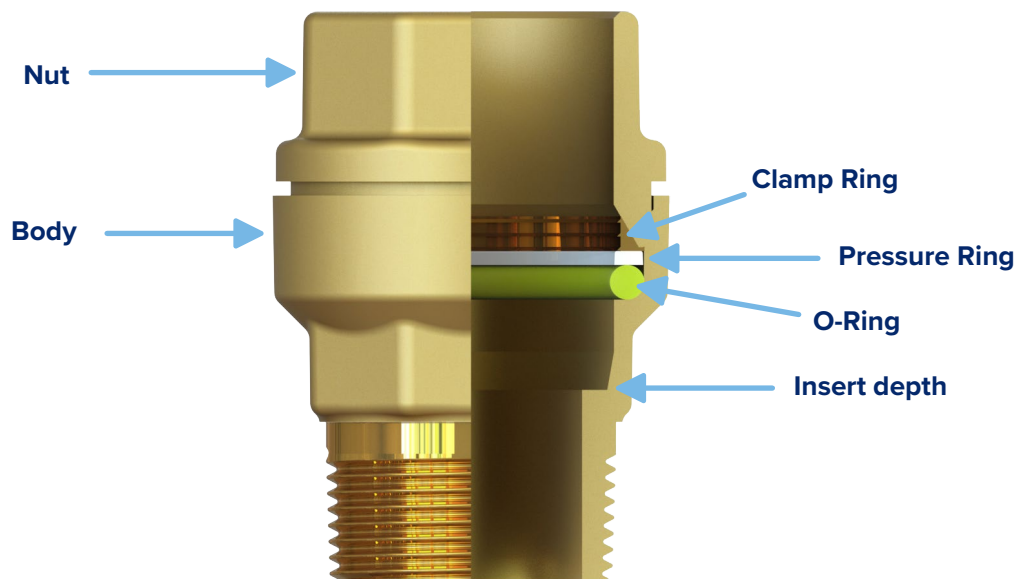

MATERIAL DESCRIPTION

BODY

DZR Brass (RA455)

O-RING

EPDM

PRESSURE RING

Composite

CLAMP RING

DZR Brass (RA455)

AREAS OF USE

WATER

Temperature: 0°C to 40°C

MOP: 16 bar

Pipes: PE 40, PE 80, PE 100 according to NS-EN 12201.

PVC according to NS-EN 1452, Copper pipes 28, 35, 42 and 54 according to NS 884.

Steel pipes 1/2" to 2" according to NS 5587. PEX pipes, if used with support liner.

Thin-walled PE pipes SDR 17 PN6 collector pipes on a heat pump, if used with support liner.

INSTALLATION INSTRUCTIONS

1.

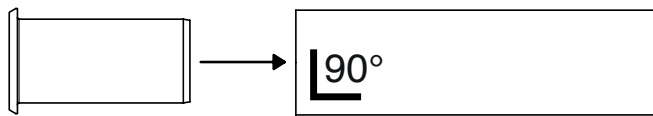

2.

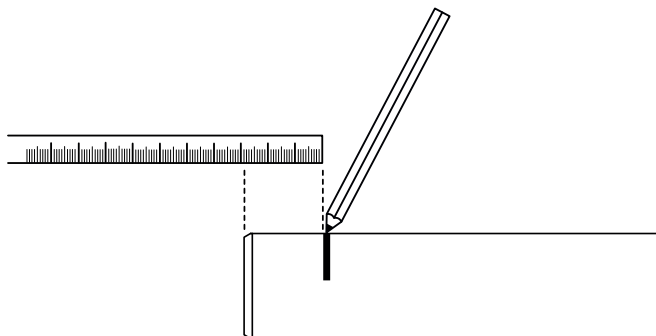

3.

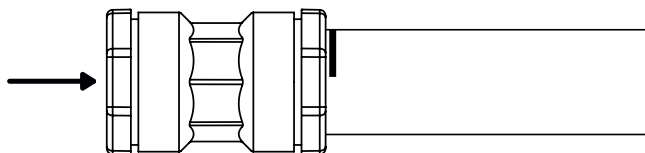

1. Cut the pipe straight, insert the Isiflo Support Insert
2. Mark the insert depth on the pipe according to the table below.
3. Loosen the nut, do not dismantle. Insert the pipe into the coupling aligned with the mark. Tighten the nut against the body.

INSERT DEPTH

COUPLINGS

Dimension	Insert Depth
20 mm	31 mm
25 mm	32 mm
32 mm	36 mm
40 mm	51 mm
50 mm	52 mm
63 mm	72 mm



REPAIR COUPLING

Dimension	Insert Depth		Max distance between pipe ends
	(min.)	(max.)	
20 mm	31 mm	56 mm	60 mm
25 mm	32 mm	56 mm	58 mm
32 mm	36 mm	57 mm	52 mm
40 mm	51 mm	77 mm	68 mm
50 mm	52 mm	77 mm	66 mm
63 mm	72 mm	79 mm	34 mm



MECHANICAL COUPLINGS

TYPE 100/102: STRAIGHT COUPLING / REDUCER

Dimension DxD	Item Number
16 x 16	6211001
20 x 15	6213001
20 x 20	6211002
20 x 21	6217202
20 x 22	6212022
20 x 25 R	6211021
21 x 21	6217232
22 x 25	6212522
25 x 15	6214123
25 x 17	6213383
25 x 21	6217201
25 x 25	6214003
27 x 25	6217203
27 x 27	6217233
28 x 25	6212528
32 x 25 R	6211023
32 x 32	6214004
34 x 32	6217204
34 x 34	6217234
35 x 32	6216005
36 x 32	6213632
40 x 25 R	6211024
40 x 28	6214028
40 x 32 R	6211025
40 x 40	6214005
40 x 50 R	6211027
40 x 63 R	6211028
42 x 38	6216006
42 x 40	6217205
42 x 42 (1 5/8"CU)	6216007
42 x 42	6217235
42 x 45	6216008
49 x 49	6217236
50 x 49	6217206
50 x 50	6211006
54 x 50	6216009
60 x 60	6217237
63 x 50 R	6211029
63 x 60	6217208
63 x 63	6211007
67 x 67	6213810



TYPE 101: REPAIR COUPLING

Dimension DxD (mm)	Item Number
20 x 20	6211012
25 x 25	6211013
32 x 32	6211014
40 x 40	6211015
50 x 50	6211016
63 x 63	6211017

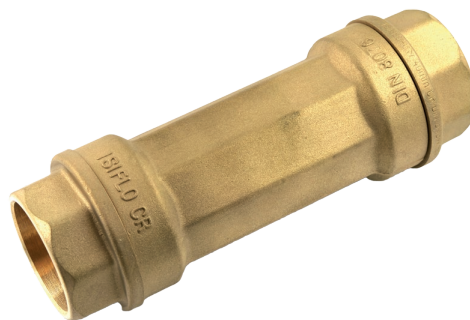

TYPE 105/110/112: MALE COUPLING

Dimension DxD	Item Number
15mm x 1/2"	6213110
16mm x 1/2"	6211051
17mm x 3/4"	6213112
20mm x 1/2"	6214102
20mm x 3/4"	6211052
21mm x 1/2"	6217212
22mm x 3/4"	6212234
25mm x 1/2"	6211123
25mm x 3/4"	6214103
25mm x 1"	6211053
27mm x 3/4"	6217213
32mm x 3/4"	6211124
32mm x 1"	6214104
32mm x 1 1/4"	6211054
32mm x 1 1/2"	6218018
34mm x 1"	6217214
40mm x 1"	6211125
40mm x 1 1/2"	6211055
40mm x 1 1/4"	6214105
42mm x 1 1/4"	6217216
49mm x 1 1/2"	6217215
50mm x 1"	6211130
50mm x 1 1/4"	6211128
50mm x 1 1/2"	6211106
50mm x 2"	6211056
60mm x 2"	6217217
63mm x 1 1/4"	2561018
63mm x 1 1/2"	6211127
63mm x 2"	6211107
67mm x 2"	6211108

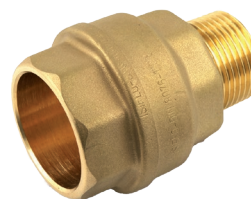

TYPE 110: MALE COUPLING

Dimension DxRxRp	Item number
75mm x 2 1/2" x 2"	6212101
75mm x 3" x 2 1/2"	6212102
90mm x 3" x 2 1/2"	6212103



D = Dimension (OD) in mm

R = Male thread ISO 7

Rp = Female thread ISO 7

TYPE 115/116: FEMALE COUPLING

Dimension DxRi	Item Number
16mm x 1/2"	6211151
20mm x 1/2"	6214162
20mm x 3/4"	6211152
21mm x 1/2"	6217221
25mm x 1/2"	6218052
25mm x 3/4"	6214163
25mm x 1"	6211153
27mm x 3/4"	6217223
32mm x 3/4"	6211161
32mm x 1"	6214164
32mm x 1 1/4"	6211154
34mm x 1"	6217224
40mm x 3/4"	6218059
40mm x 1"	6211168
40mm x 1 1/4"	6214165
40mm x 1 1/2"	6211155
42mm x 1 1/4"	6217225
49mm x 1 1/2"	6217226
50mm x 1 1/4"	6211169
50mm x 1 1/2"	6211166
50mm x 2"	6211156
60mm x 2"	6217227
63mm x 2"	6211167
67mm x 2"	6213812



TYPE 120: ELBOW 90°

Dimension D (mm)	Item Number
20mm	6211202
25mm	6211203
27mm	6217243
32mm	6211204
34mm	6217244
40mm	6211205
40mm x 28mm	6214029
50mm	6211206
63mm	6211207
67mm x 67mm	on request



TYPE 123: ELBOW 45°

Dimension DxD (mm)	Item Number
25mm	6211233
32mm	6211234
40mm	6211235
50mm	6211236
63mm	6211237



TYPE 121/124: MALE ELBOW

Dimension DxD (mm)	Item Number
20mm x 1/2"	6210212
20mm x 3/4"	6211212
25mm x 1/2"	6211243
25mm x 3/4"	6214613
25mm x 1"	6211213
32mm x 3/4"	6211244
32mm x 1"	6214614
32mm x 1 1/4"	6211214
40mm x 1"	6211245
40mm x 1 1/4"	6210215
40mm x 1 1/2"	6211215
50mm x 1"	6210246
50mm x 1 1/4"	6211246
50mm x 1 1/2"	6210216
50mm x 2"	6211216
63mm x 1 1/2"	6211247
63mm x 2"	6211217

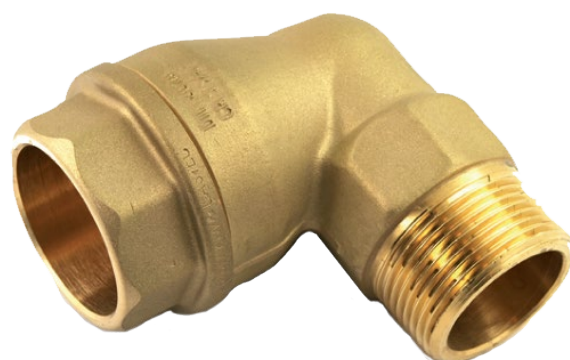

TYPE 129: SWIVEL ELBOW 90°

Dimension DxD	Item Number
32mm x 1"	6210280
32mm x 1 ¼"	6211293
40mm x 1 ¼"	6211295
40mm x 1 ½"	6211298
50mm x 1 ½"	6211294
63mm x 2"	6211299



TYPE 122: FEMALE ELBOW 90°

Dimension DxD	Item Number
20mm x ½"	6211222
25mm x ½"	6218049
25mm x ¾"	6214223
32mm x ¾"	6218050
32mm x 1"	6211224
40mm x ¾"	6218061
40mm x 1"	6218060
40mm x 1 ¼"	6211225
50mm x 1 ¼"	6218051
50mm x 1 ½"	6211226
63mm x 2"	6211227



TYPE 229: DOUBLE SWIVEL ELBOW 90°

Dimension DxD	Item Number
32mm x 1 ¼"	6212292
32mm x 1 ½"	6212293
40mm x 1 ¼"	6212291
40mm x 1 ½"	6212298
50mm x 1 ¼"	6212295
50mm x 1 ½"	6212294
63mm x 2"	6212299



TYPE 131: TEE MALE

Dimension DxD	Item Number
20 x ½" x 20mm	6211312
25 x ¾" x 25mm	6211313
32 x 1" x 32mm	6211314
40 x 1 ¼" x 40mm	6211315
50 x 1 ½" x 50mm	6211316
63 x 2" x 63mm	6211317

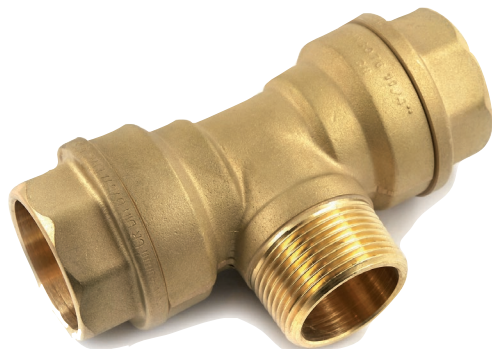

TYPE 125/130: TEE

Dimension DxDxD	Item Number
16 x 16 x 16mm	6211251
20 x 20 x 20mm	6211252
25 x 20 x 25mm	6211300
25 x 25 x 25mm	6214253
27 x 27 x 27mm	6217253
32 x 25 x 32mm	6211304
32 x 32 x 32mm	6214254
34 x 34 x 34mm	6217254
40 x 32 x 40mm	6211305
40 x 40 x 40mm	6211255
50 x 32 x 50mm	6211308
50 x 40 x 50mm	6211306
50 x 50 x 50mm	6211256
63 x 32 x 63mm	6211309
63 x 40 x 63mm	6211307
63 x 63 x 63mm	6211257
67 x 67 x 67mm	på foresp.
75 x 75 x 75mm	6241251
90 x 90 x 90mm	6241252
110 x 110 x 110mm	6241253



TYPE 132: TEE FEMALE

Dimension DxD	Item Number
20 x 1/2" x 20mm	6211322
25 x 3/4" x 25mm	6211323
32 x 1" x 32mm	6211324
40 x 1 1/4" x 40mm	6211325
50 x 1 1/2" x 50mm	6211326
63 x 2" x 63mm	6211327



TYPE 139: DUO COUPLING - TO SEAL INNER AND OUTER PIPE ON A DUO-PIPE SYSTEM

Dimension DxD	Item Number
40 mm x 25 mm	6213023
50 mm x 32 mm	6213024
63 mm x 40mm	6213025



BUILDING BLOCK SYSTEM

REDUCER TYPE 135 og 140

With adapters Isiflo couplings can be rebuilt from 16 mm to 63 mm. It is also possible to reduce or rebuild to female and male threads.

Example:

Reduce or rebuild to female or male threads.

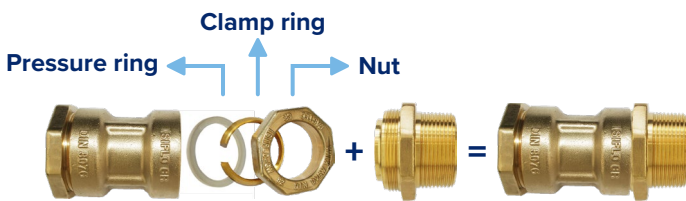

Remove nut, clamp ring and pressure ring.

NB: O-ring must always remain inside the coupling!

New part is tightened to impact.

TYPE 135/140: REDUCER

Dimension Dx D (mm)	Item Number
25 x 16mm	6211403
25 x 20mm	6211353
32 x 20mm	6211404
32 x 25mm	6211354
32 x 27mm	6217354
40 x 25mm	6211405
40 x 32mm	6211355
40 x 34mm	6217355
40 x 38mm	6211408
50 x 32mm	6211406
50 x 40mm	6211356
63 x 40mm	6211409
63 x 50mm	6211358
63 x 57mm	6211410



TYPE 142: ADAPTOR FOR STEEL PIPES

Dimension DxD (mm)	Item Number
25mm x ¾"	6211423
32mm x 1"	6211424
40mm x 1 ¼"	6211425
50mm x 1 ½"	6211426
63mm x 2"	6211428



TYPE 143: DOUBLE SWIVEL NIPPLE

Dimension DxD (mm)	Item Number
25mm	6211433
32mm	6211434
40mm	6211435



TYPE 144: DOUBLE CONNECTION NIPPLE

Dimension DxD (mm)	Item Number
25mm	6218043
32mm	6218048
40mm	6218044
50mm	6218045
63mm	6211447



TYPE 145: BLANKING PLUG

Dimension D (mm)	Item Number
16mm	6211451
20mm	6211452
25mm	6211453
32mm	6211454
40mm	6211455
50mm	6211456
63mm	6211458



TYPE 146/147: MALE CONNECTION NIPPLE

Dimension DxD (mm)	Item Number
20mm x 1/2"	6211472
20mm x 3/4"	6211462
25mm x 3/4"	6211473
25mm x 1"	6211463
32mm x 1"	6211474
32mm x 1 1/4"	6211464
32mm x 1 1/2"	6211468
40mm x 1 1/4"	6211475
40mm x 1 1/2"	6211465
50mm x 1 1/2"	6211476
50mm x 2"	6211466
63mm x 2"	6211478



TYPE 148/149: FEMALE CONNECTION NIPPLE

Dimension DxD (mm)	Item Number
20mm x 1/2"	6211482
25mm x 1/2"	6211493
25mm x 3/4"	6211483
25mm x 1"	6218004
32mm x 3/4"	6211494
32mm x 1"	6211484
40mm x 3/4"	6211498
40mm x 1"	6211495
40mm x 1 1/4"	6211485
42mm x 1 1/4"	6211488
50mm x 1 1/4"	6211496
50mm x 1 1/2"	6211486
63mm x 2"	6211489



TYPE 150: WALL FIXING NIPPLE ELBOW

Dimension DxD (mm)	Item Number
16mm x 1/2"	6211501
20mm x 1/2"	6211502
25mm x 1/2"	6211504
25mm x 3/4"	6211503



BRASS GATE VALVE

TYPE 200: GATE VALVE

Dimension DxD (mm)	Item Number
25 x 25mm	6212003
32 x 32mm	6212004



TYPE 200: GATE VALVE

Dimension DxD (mm)	Item Number
40 x 40mm	6216040
50 x 50mm	6216050
63 x 63mm	6216063



BUILDING BLOCK SYSTEM

**TYPE 200 + 148/149 GATE VALVE WITH PE
AND FEMALE CONNECTION**



**TYPE 200 + 146/147 GATE VALVE WITH
MALE CONNECTION**



**TYPE 200 + 146/147 + 229 GATE VALVE
WITH MALE AND DOUBLE SWIVEL ELBOW
(TAPPING SOLUTION)**

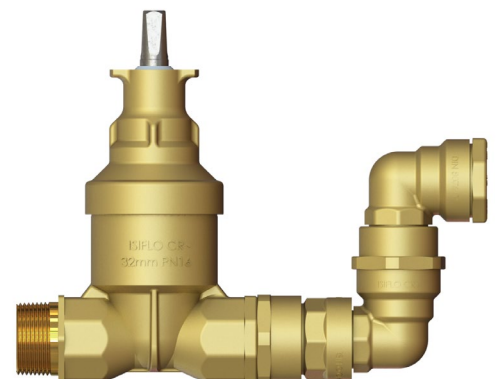

SUPPORT INSERT



WHY USE SUPPORT INSERT

To ensure that your Isiflo connection is the strongest part of the piping system, use the Isiflo support Insert. The Support Insert is designed to support the interior wall of high-density polyethylene pipe for critical joining applications. The Insert supports the HDPE pipe's end and makes connection end-load resistant. Use of Support Liner will not disturb the flow due to the Venturi system inside of the Seal Liner. The Isiflo Support Insert is made of PA-12 composite material.

EXAMPLE

The image below shows an example of stretch with the use of Seal Insert.



TYPE 181: SUPPORT INSERT SDR 11

Dimension DxD (mm)	Item Number
20 x 2,0 mm	8211802
25 x 2,3 mm	8211803
32 x 3,0 mm	8211804
40 x 3,7 mm	8211805
50 x 4,6 mm	8211806
63 x 5,8 mm	8211807

TYPE 180: SUPPORT INSERT SDR 17

Dimension DxD (mm)	Item Number
32 x 2/2,3 mm	8211814
40 x 2,4mm	8211815
50 x 3,0 mm	8211816
63 x 3,8 mm	8211817

NOTES:



THREADED PIPE FITTINGS

ELBOW (2 X FEMALE THREAD)

Dimension	Item Number
1/8"	5010003
1/4"	5010006
3/8"	5010009
1/2"	5010013
3/4"	5010016
1"	5010019
1 1/4"	5010023
1 1/2"	5010026
2"	5010033
2 1/2"	5010039
3"	5010043



REDUCING ELBOW

Dimension	Item Number
1/2" x 3/8"	5010066
3/4" x 1/2"	5010073
1" x 3/4"	5010079



ELBOW (FEMALE THREAD X MALE THREAD)

Dimension	Item Number
1/4"	5010302
3/8"	5010304
1/2"	5010306
3/4"	5010308
1"	5020146
1 1/4"	5010313
1 1/2"	5010315
2"	5010317



BACKNUT

Dimension	Item Number
1/8"	5010503
1/4"	5010506
3/8"	5010509
1/2"	5010513
3/4"	5010516
1"	5010519
1 1/4"	5010523
1 1/2"	5010526
2"	5010533
2 1/2"	5010539



CONNECTIONS

Dimension	Item Number
1 1/2"	5010576



CONNECTION WITH CHAMFER

Dimension	Item Number
1/8"	5011003
1/4"	5011006
3/8"	5011009
1/2"	5011013
3/4"	5011016
1"	5011019
1 1/4"	5011023
1 1/2"	5011026
2"	5011033
2 1/2"	5011039
3" On special request	5010043



REDUCTION WITH CHAMFER

Dimension	Item Number
1/2" x 1/4"	5011061
1/2" x 3/8"	5011069
3/4" x 1/2"	5011083
1" x 1/2"	5011089
1" x 3/4"	5020238



ENDING

Dimension	Item Number
1/8"	5011303
1/4"	5011306
3/8"	5011309
1/2"	5011313
3/4"	5011316
1"	5011319
1 1/4"	5011323
1 1/2"	5011326
2"	5011329
2 1/2"	5011339
3"	5011343



CROSS

Dimension	Item Number
3/4"	5011416
1"	5011419



SOCKET

Dimension	Item Number
1/8"	5011503
1/4"	5011506
3/8"	5011509
1/2"	5011513
3/4"	5011516
1"	5011519
1 1/4"	5011523
1 1/2"	5011526
2"	5011533
2 1/2"	5011539
3"	5011543
4"	5011545



REDUCING SOCKET

Dimension	Item Number
1/4" x 1/8"	5011703
3/8" x 1/8"	5011706
3/8" x 1/4"	5011709
1/2" x 1/4"	5011713
1/2" x 3/8"	5011716
3/4" x 3/8"	5011719
3/4" x 1/2"	5011723
1" x 1/2"	5011726
1" x 3/4"	5011729
1 1/4" x 3/4"	5011733
1 1/4" x 1"	5011736
1 1/2" x 1"	5011739
1 1/2" x 1 1/4"	5011743
2" x 1 1/4"	5011746
2" x 1 1/2"	5011749



REDUCING NIPPLE

Dimension	Item Number
1/4" x 1/8"	5012103
3/8" x 1/8"	5012106
3/8" x 1/4"	5012109
1/2" x 1/4"	5012113
1/2" x 3/8"	5012116
3/4" x 3/8"	5012119
3/4" x 1/2"	5012123
1" x 1/2"	5012126
1" x 3/4"	5012129
1 1/4" x 3/4"	5012133
1 1/4" x 1"	5012136
1 1/2" x 1"	5012141
1 1/2" x 1 1/4"	5012143
2" x 1"	5012146
2" x 1 1/4"	5012147
2" x 1 1/2"	5012149
2 1/2" x 2"	5012153
3" x 2"	5012156
3" x 2 1/2"	5012159



HEXAGON NIPPLE

Dimension	Item Number
1/8"	5012003
1/4"	5012006
3/8"	5012009
1/2"	5012013
3/4"	5012016
1"	5012019
1 1/4"	5012023
1 1/2"	5012026
2"	5012033
2 1/2"	5012039
3"	5012043



CONNECTOR (MALE THREAD X FEMALE THREAD)

Dimension	Item Number
1/8"	5011803
1/4"	5011806
3/8"	5011809
1/2"	5011813
3/4"	5011816
1"	5011819
1 1/4"	5011823
1 1/2"	5011826
2"	5011833
2 1/2"	5011839
1/8" x 1/4"	5011853
1/4" x 1/8"	5011859
1/4" x 3/8"	5011863
3/8" x 1/4"	5011866
3/8" x 1/2"	5011869
1/2" x 3/8"	5011873
1/2" x 3/4"	5011876
3/4" x 1/2"	5011879
3/4" x 1"	5011883
1" x 3/4"	5011886
1" x 1 1/4"	5011889
1 1/4" x 1"	5011893
1 1/4" x 1 1/2"	5011896
1 1/2" x 1 1/4"	5011899



REDUCING BUSH (MALE THREAD X FEMALE THREAD)

Dimension	Item Number
1/4" x 1/8"	5012303
3/8" x 1/8"	5012306
3/8" x 1/4"	5012309
1/2" x 1/8"	5012313
1/2" x 1/4"	5012316
1/2" x 3/8"	5012319
3/4" x 1/4"	5012323
3/4" x 3/8"	5012326
3/4" x 1/2"	5012329
1" x 3/8"	5012333
1" x 1/2"	5012336
1" x 3/4"	5012339
1 1/4" x 1/2"	5012343
1 1/4" x 3/4"	5012346
1 1/4" x 1"	5012349
1 1/2" x 1/2"	5012353
1 1/2" x 3/4"	5012356
1 1/2" x 1"	5012359
1 1/2" x 1 1/4"	5012363
2" x 1"	5012366
2" x 1 1/4"	5012369
2" x 1 1/2"	5012373
2 1/2" x 1 1/2"	5012373
2 1/2" x 2"	5012379
3" x 2"	5012383
3" x 2 1/2"	5012386
4 x 3"	5012391



STRAIGHT NIPPLE

Dimension	Item Number
1/4"	5012506
3/8"	5012509
1/2"	5012513
3/4"	5012516
1"	5012519
1 1/4"	5012523
1 1/2"	5012526
2"	5012533



PLUG

Dimension	Item Number
1/8"	5012553
1/4"	5012556
3/8"	5012559
1/2"	5012563
3/4"	5012566



PLUG

Dimension	Item Number
1"	5012569
1 1/4"	5012573
1 1/2"	5012576
2"	5012583
2 1/2"	5012589
3"	5012593

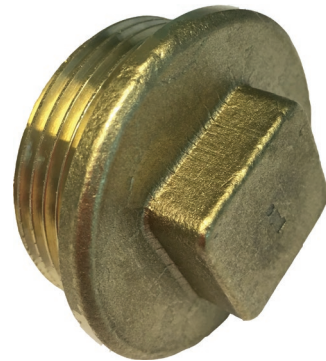

TEE

Dimension	Item Number
1/8"	5012703
1/4"	5012706
3/8"	5012709
1/2"	5012713
3/4"	5012716
1"	5012719
1 1/4"	5012723
1 1/2"	5012726
2"	5012733
2 1/2"	5012739
3"	5012743



REDUCING TEE

Dimension	Item Number
1/2" x 3/8"	5012773
3/4" x 1/2"	5012786
1" x 1/2"	5012793
1" x 3/4"	5012796
1 1/4" x 1"	5012806
1 1/2" x 1"	5012809
2" x 1"	5012816



TEE WITH 2 COUPLINGS

Dimension	Item Number
3/8"	5013309
1/2"	5013313
3/4"	5013316
1"	5013319



STRAIGHT FEMALE UNION CONNECTOR

Dimension	Item Number
1/8"	5013703
1/4"	5013706
3/8"	5013709
1/2"	5013713
3/4"	5013716
1"	5013719
1 1/4"	5013723
1 1/2"	5013726
2"	5013729



STRAIGHT MALE UNION CONNECTOR

Dimension	Item Number
1/4"	5013906
3/8"	5013909
1/2"	5013913
3/4"	5013916
1"	5013919
1 1/4"	5013923
1 1/2"	5013926
2"	5013929
3"	5013936



COUPLING NUT

Dimension	Item Number
1/8"	5014053
1/4"	5014056
3/8"	5014059
1/2"	5014063
3/4"	5014066
1"	5014069
1 1/4"	5014073
1 1/2"	5014076
2"	5014079



ACCESSORIES

ISIFLO KEYS

Dimension	Item Number
20-25mm	6211941
25-32/40mm	6211944
50-63mm	6211943
Key set 25–63mm	6211940



TYPE 181: SUPPORT INSERT SDR 11

Dimension DxD (mm)	Item Number
20x2,0 mm	8211802
25x2,3 mm	8211803
32x3,0 mm	8211804
40x3,7 mm	8211805
50x4,6 mm	8211806
63x5,8 mm	8211807



TYPE 180: SUPPORT INSERT SDR 17

Dimension DxD (mm)	Item Number
32x2/2,3 mm	8211814
40x2,4mm	8211815
50x3,0 mm	8211816
63x3,8 mm	8211817

TYPE 210: CLOSING TOOL FOR SPINDEL

Dimension DxD (mm)	Item Number
16 x 16mm	6216065



GATE VALVE SET WITH SPINDEL

Dimension DxD (mm)	Item Number
32mm Reduction down to 25mm included.	6218981



TYPE 330: SPINDELS

Dimension DxD (mm)	Item Number
450-750mm	6216210
550-950mm	6216211
910-1660mm	6216212
1250-2350mm	6216213
2050-3950mm	6216214



TYPE 350: STREET COVERS

Dimension DxD (mm)	Item Number
D=205mm black	6216080
D=205mm blue	6216082
185x185mm black	6216081
185x185mm blue	6216083



DUCTILE IRON PRODUCTS

TECHNICAL INFORMATION

MATERIAL DESCRIPTION

BODY

GGG 50

O-RING

NBR

BOLTS AND NUTS

Acidproof steel A4

COATING

Rilfan

AREAS OF USE

WATER

Temperature: 0°C to 40°C

MOP/ Operating pressure: Max 16 bar

Pipes: PE- PVC- PEX-rør



TYPE 101: STRAIGHT COUPLING

Dimension	Item Number
75 x 75 mm	6241001
90 x 90 mm	6241002
110 x 110 mm	6241003
160 x 160 mm	6241006



TYPE 110: MALE COUPLING

Dimension	Item Number
75 mm x 2 1/2"	6241101
90 mm x 3"	6241103
110 mm x 4"	6241104

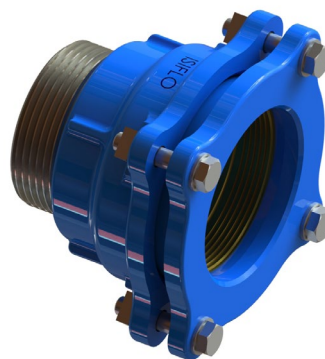

TYPE 120: ELBOW 90°

Dimension	Item Number
75 x 75 mm	6241201
90 x 90 mm	6241202
110 x 110 mm	6241203
160 x 160 mm	6241206



TYPE 123: ELBOW 45°

Dimension	Item Number
75 x 75 mm	6241231
90 x 90 mm	6241232
110 x 110 mm	6241233



TYPE 125: TEE

Dimension	Item Number
75 x 75 x 75 mm	6241251
90 x 70 x 90 mm	6241252
110 x 110 x 110 mm	6241253
160 x 160 x 160mm	6241256



TYPE 160: FLANGE ADAPTOR

Dimension	Item Number
75 mm x DN 65	6241601
90 mm x DN 80	6241602
110 mm x DN 100	6241603
160 mm x DN 150	6241606



TYPE 147: THREADED ADAPTOR

Dimension	Item Number
75 mm x 2"	6241201
90 mm x 2"	6241202
110 mm x 3"	6241203
160 mm x 4"	6241206

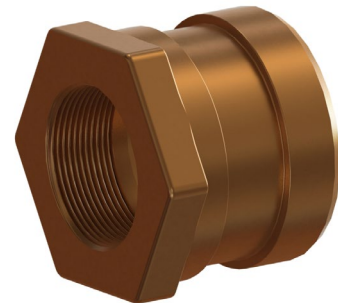

TYPE 148: FLANGE ADAPTOR

Dimension	Item Number
75 mm x DN 65	6241481
90 mm x DN 80	6241482
110 mm x DN 100	6241483
160 mm x DN 150	6241486

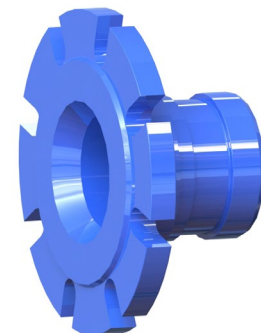

NOTES:



isiflo®

ENVIRONMENT



DAILY FOCUS ON ENVIRONMENTAL PERFORMANCE

We are committed to protecting the environment and we are actively working to reduce any negative environmental impacts that are results from our operations. We are engaged in environmental work and want to work long-term with dedication to implement environmental improvement measures in our businesses.

We are certified and work in accordance with ISO 14001 -2015, as well as relate to the public requirements and the information duty regarding important environmental aspects.

We work actively to reduce our energy consumption and CO2 footprint. Throughout the entire production and distribution chain, we consider environmental measures; from commodity production to retail. Local, regional and global environmental aspects is taken care of. Our goal is to have a sustainable development, so that we take the future generations into account. We use 100% renewable energy in our production, and work with local suppliers in addition to perform active search for more sustainable materials and processes. to improve our carbon footprint.

CORPORATE ENVIRONMENTAL POLICY

- We work actively to avoid environmental emissions and pollution.
- We use short-lived raw materials and minimize the handling of goods at work.
- We optimize the transport of goods to our customers.
- We recycle waste from our production.
- We are sorting 100% of our waste into environmental stations.
- We monitor our performance through internal evaluations and reporting, and sharing the results with our stakeholders.
- We require our subcontractors and partners to follow the same principles.
- We have our own development department focusing on research and development of environmentally friendly -and future oriented products.
- We provide necessary information, instruction and training.
- We join international networks to stay on top of the future regulations and learn for new initiatives to improve our sustainable performance.

STANDARDS

ISO 14001

The corporate environmental policy is an integral part of Isiflo AS business strategy, and we are dedicated to implement, maintain and improve our environmental performance. The same way our products have to meet an international demand of high quality, Isiflo AS is certified pursuant to ISO 14001, the international standards of environmental management.

ISO 9001

Isiflo AS holds in addition the certificate ISO 9001:2000. ISO 9001:2000 is a series of international standards that specifies requirements for a quality management system. The organization needs to demonstrate its ability to consistently provide product that meets customer and applicable regulatory requirements, and aims to enhance customer satisfaction through the effective application of the system, including processes for continual improvement of the system and the assurance of conformity to customer and applicable regulatory requirements.

CONCEPT

The Isiflo business concept implements lasting values through the development and supply of environmental friendly products of high quality to meet all customer requirements related to water, drainage and gas distribution networks. Environmental measures shall be taken into consideration throughout the production and distribution chain; ranging from the production of raw material to the end user. Local, regional and global environmental aspects shall be considered.

GENERAL CONDITIONS OF SALE

1. GENERAL

1.1. These general conditions of sale, together with our offer and order acceptance, constitute the entire agreement between the parties unless explicitly set aside in the order acceptance or by written agreement between the parties. The customer's general purchase terms or terms and conditions contained in other documents apply only if explicitly accepted in writing by us. In the event of conflict between the documents of the agreement they shall have priority as follows: the offer, the order acceptance and the general conditions.

2. OFFER, SALE, QUALITY

2.1. The purchaser accepts our General Conditions of sale at the time of receipt of our order confirmation.

2.2. Standard products are delivered, unless otherwise stated, in our normal quality and with our usual dimensional tolerances. **2.3.** Specifications concerning weight, dimensions, performance, ratings, prices, technical and other data, included in booklets, catalogues, prospects, circulars, advertisements, price lists, web page etc., constitute an approximate guide and are not binding on us unless they are explicitly included in the agreement.

3. QUANTITY

3.1. Under agreements to supply goods, which are not stock goods in standard packaging, we have the right to deliver up to 10% more or less than the agreed quantity unless a different margin is specifically agreed. The customer is not entitled to claim delivery compensation, or to reject delivered goods as long as we keep within this margin. Deliveries exceeding the agreed quantity will be charged at the agreed unit price. Unless otherwise agreed, we are entitled to undertake part deliveries. **3.2.** Non-standard goods cannot be returned. **3.3.** Standard goods can be returned with the return allowance of 20% of net purchase price + shipping. The product must be in salable condition and in original packaging.

4. DELIVERY

4.1. Delivery dates and periods stated by us are non-binding unless agreed otherwise. Binding dates are not fixed dates if they are not expressly stated as such. **4.2.** Unless otherwise agreed our terms of delivery is EXW Raufoss (Incoterms 2016) from a location designated by us, and the method of packaging and the packaging material will be determined by us. **4.3.** If the agreement calls for final specification of delivery by a stated date, the customer is obliged to furnish the specification by that date. If he fails to do so, we have the right to cancel and claim compensation or make the specification ourselves and deliver at our own option. If the customer specifies for a larger quantity than the original order, and we are able to deliver, he will be charged for the excess at the price applying at the time of delivery. **4.4.** The customer is not entitled to cancel by reason of delay except as otherwise specifically agreed or unless it would be evidently unreasonable to keep the agreement. Nor does delayed delivery entitle the customer to present any other claim, including any claim for compensation, unless specifically agreed in writing.

5. FORCE MAJEURE

5.1. If after the conclusion of an agreement any circumstances occur which are beyond our control and which render impossible or considerably impede due performance of our obligations, the customer is barred from claiming compensation and the delivery date will be postponed. Such circumstances include, but are not limited to industrial disputes, fire, flood, lightning, landslide, war, mobilization and other military drafting of similar extent, requisitioning, embargo, currency restrictions, shortage of transport, breakdown of machinery, export and import restrictions, insurrection, riots and disturbances, industrial accidents, insufficient supply of raw materials, water, power and fuel, default in contracts with subcontractors, and other substantial interference with production. **5.2.** Delays due to any circumstances as aforesaid do not entail any cancellation right unless the delays are of a permanent nature. In such case either party may cancel the agreement in whole or in part. **5.3.** If we intend to invoke any circumstance as aforesaid, we are obliged to notify the customer thereof without undue delay.

6. TERMS OF PAYMENT

6.1. Unless otherwise agreed our terms of payment are date of invoice + 20 days. Goods will be invoiced at the date of delivery. **6.2.** If the customer fails to pay any invoice when due, we shall have the right to charge interest on the delayed amount as well as defer deliveries under this or any other contract with the customer. **6.3.** We reserve the right to require the customer to furnish, before delivery, security acceptable to us for due payment. **6.4.** In any case we may invoice the goods when we are ready for delivery, when the customer has delayed delivery, and this delay is not due to fault on our part. **6.5.** All installment deliveries may be separately invoiced and shall be paid for without regard to subsequent deliveries. Delays in delivery or non-conformities in any instalments shall not relieve customer of his obligation to accept and pay for remaining installments. **6.6.** All goods remain the property of Isiflo AS until payment is received in full.





www.isiflo.com

Your Isiflo representative:

Certifications:



ISO 17885